

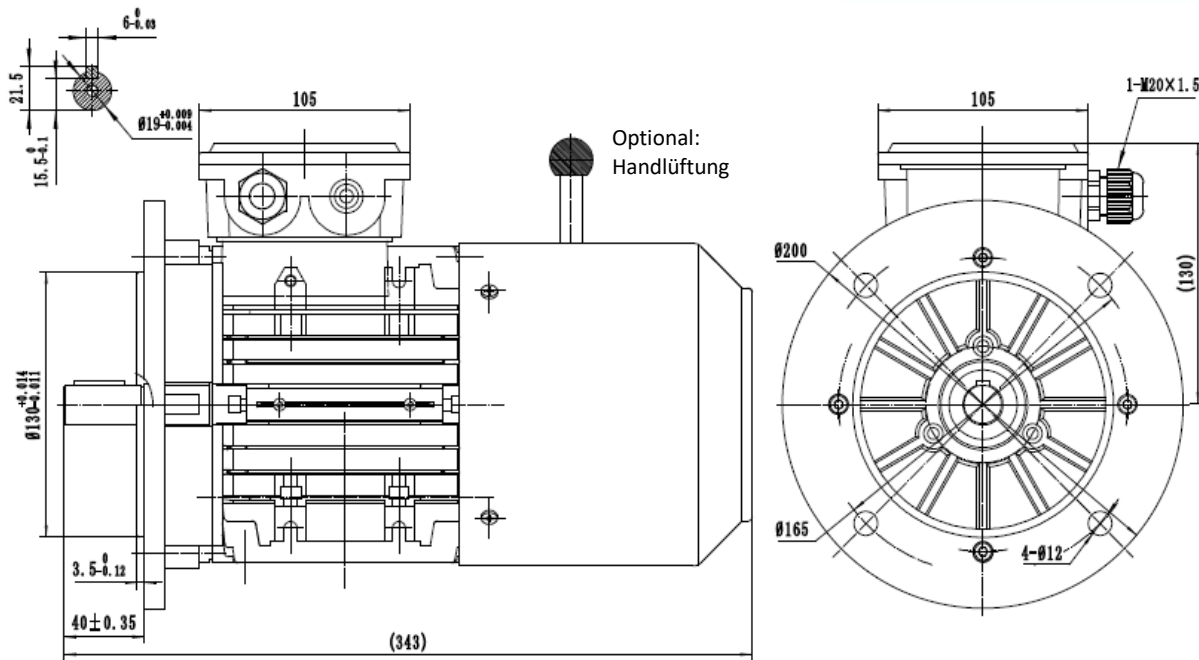

Drehstrombremsmotor / Three-Phase-Brakemotor

IE3 - 0,25 kW - 8 polig / 8 pole B5



Typ / type

SEV-BM3 802-8

Gehäusematerial / frame material		Aluminum	Nennmoment / rated torque	3,41
Ausführung / execution		Dreiphasen/ three phase	Anzugs- zu Nennmoment / start- to rated torque	2,1
Baugröße / frame size		80	Kipp- zu Nennmoment / brakedown- to rated torque	2,5
Leistung / power @50Hz	kW	0,25	min. Dreh- zu Nennmoment / min- to rated torque	2
Nennstrom / rated current @230V	Δ	1,58	Anzugs- zu Nennstrom / starting- to rated current	3,5
Nennstrom / rated current @400V	Y	0,91	Lager / bearing (DE)	6204-2RZ
Drehzahl / speed @50Hz	(r/min)	700	Lager / bearing (NDE)	6204-2RZ
Wirkungsgrad / efficiency	IE3		Wellendichtung / shaft seal (DE/NDE)	20x34x7
	Eff. 100%	66,90	Hauptkabelverschraubung / main cable glands	1-M20*1.5
	Eff. 75%	61,90	Isolationsklasse / insulation class	F
	Eff. 50%	57,70	Schutzart / protection degree	IP 55
Leistungsfaktor / power factor cosφ	100% load	0,59	Thermischer Schutz / thermal protection	3*PTC
60Hz 265/460V	Power(kW)	0,29	Drehrichtung / rotation direction	rechts-links / clockwise-counterclockwise
60Hz 276/480V	Power(kW)	0,30	Einschaltdauer / service duty	S1
Drehzahl / speed @60Hz	(r/min)	840	Wuchtung / balance	Halbkeilwuchtung / half-key balanced
Ausführung Bremse / execution brake		BLC457-08	Kühlungsart / cooling	IC 411
Bremsmoment / braking torque (@ 100 Upm / rpm)		8	Lautstärke / noise dB(A)	52
Normen / regulations		IEC / DIN / ISO / VDE / EN	Nettogewicht / net weight(kg)	11,92
Standard / standard		IEC 60034	Massenträgheitsmoment / moment of inertia (kg*m ²)	0,002322554
Umgebungstemperatur / ambient Temp.		-20°C ~ +40°C	Aufstellungshöhe / altitude (max.)	1000m über Meeresspiegel / above sea level