

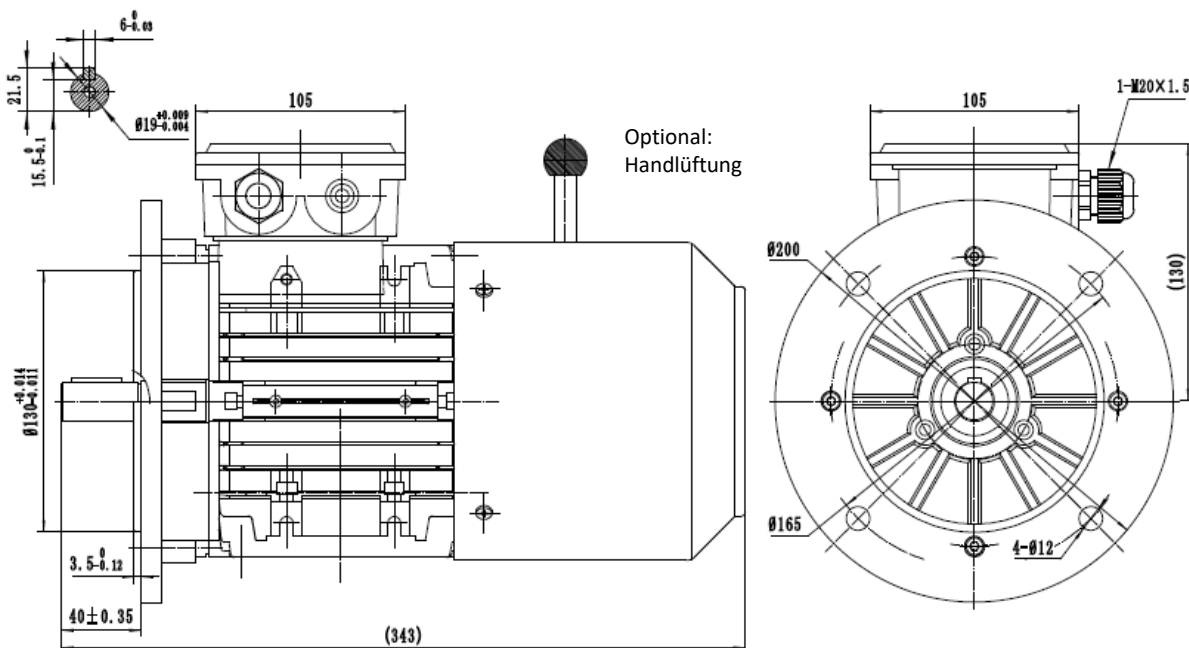

Drehstrombremsmotor / Three-Phase-Brakemotor
IE3 - 0,55 kW - 6 polig / 6 pole B5



Typ / type **SEV-BM3 802-6**

Gehäusematerial / frame material		Aluminum	Nennmoment / rated torque	5,65
Ausführung / execution		Dreiphasen/ three phase	Anzugs- zu Nennmoment / start- to rated torque	2,3
Baugröße / frame size		80	Kipp- zu Nennmoment / brakedown- to rated torque	2,4
Leistung / power @50Hz	kW	0,55	min. Dreh- zu Nennmoment / min- to rated torque	2,1
Nennstrom / rated current @230V	Δ	2,51	Anzugs- zu Nennstrom / starting- to rated current	4,3
Nennstrom / rated current @400V	Y	1,45	Lager / bearing (DE)	6204-2RZ
Drehzahl / speed @50Hz	(r/min)	930	Lager / bearing (NDE)	6204-2RZ
Wirkungsgrad / efficiency	IE3		Wellendichtung / shaft seal (DE/NDE)	20x34x7
	Eff. 100%	77,20	Hauptkabelverschraubung / main cable glands	1-M20*1.5
	Eff. 75%	78,10	Isolationsklasse / insulation class	F
	Eff. 50%	75,70	Schutzart / protection degree	IP 55
Leistungsfaktor / power factor cosφ	100% load	0,71	Thermischer Schutz / thermal protection	3*PTC
60Hz 265/460V	Power(kW)	0,63	Drehrichtung / rotation direction	rechts-links / clockwise-counterclockwise
60Hz 276/480V	Power(kW)	0,66	Einschaltdauer / service duty	S1
Drehzahl / speed @60Hz	(r/min)	1115	Wuchtung / balance	Halbkeilwuchtung / half-key balanced
Ausführung Bremse / execution brake		BLC457-08	Kühlungsart / cooling	IC 411
Bremsmoment / braking torque (@ 100 Upm / rpm)		12	Lautstärke / noise dB(A)	56
Normen / regulations		IEC / DIN / ISO / VDE / EN	Nettogewicht / net weight(kg)	13,52
Standard / standard		IEC 60034	Massenträgheitsmoment / moment of inertia (kg*m ²)	0,002930586
Umgebungstemperatur / ambient Temp.		-20°C ~ +40°C	Aufstellungshöhe / altitude (max.)	1000m über Meeresspiegel / above sea level